

AUSSENLEUCHTEN



MOLTO LUCE®









Foto: Gareth Gardner







BODENEINBAU

 SPIACAR 04-05	 MAXISPIACAR 06-07	 NEO 08-09	 MAXISEGNO FLAT 10-11	 MAXISEGNO 10-11
---	---	---	---	---

WANDEINBAU

 MARGIN WALL GRID 12-13	 VERSO FLAT 14	 MAXIVERSO FLAT 14	 LONGVERSO FLAT 15	 PASSO 16-17	 LONGPASSO 16-17
---	---	--	--	---	--



WANDAUFBAU

 VERSO FLAT 18-19	 MAXIVERSO FLAT 18-19	 LONGVERSO FLAT 18-19	 VERSO FLAT 20-21	 MAXIVERSO FLAT 20-21	 MICROBIVIO 22	 MINIMODO 22
--	---	---	--	---	--	---

DECKENAUFBAU

 MEGAPUNTO 23	 MEGAPUNTO 23
--	--

POLLER

 TONDO 24-25	 COMPATTO P 26-27
---	--

STRAHLER

 MEGASEGNO SPOT 28	 MINIPARIO 29	 MICROFARO FLAT 30	 FARO FLAT 30	 MINIPARIO EXTENSION 31
--	--	--	--	---



SPIACAR

INFORMATION

Bodeneinbauleuchte, quadratisch, Aluminiumdruckguss, Abdeckring und Schrauben aus Edelstahl, Diffusor aus gehärtetem Glas, mit 0,5m Gummikabel H07RN8-F, Silikon-dichtung, Überfahrt mit max. 15km/h, Statische Belastung 2500 kg, inkl. Konverter, Einbaugehäuse muss separat bestellt werden.



LEISTUNG	LUMEN	CRI>	KELVIN	L x B x ET	FARBE	OPTIK	REFL.	ART.NR.
SYS 8W	131	80	3000	135 x 135 x 115	edelstahl	opal	114°	57-gh1245ahxw300en15
EINBAUGEHÄUSE INFO				ABBILDUNG	Ø x ET	FARBE	ART.NR.	
Einbaugehäuse, rund, für SPIACAR, separat ordern					125 x 115	schwarz	57-ac014	
EINBAUGEHÄUSE INFO				ABBILDUNG	Ø x ET	FARBE	ART.NR.	
Einbaugehäuse, rund, für SPIACAR, separat ordern					125 x 85	schwarz	57-ac273	



SPIACAR

INFORMATION

Bodeneinbauleuchte, rund, Aluminiumdruckguss, Abdeckring und Schrauben aus Edelstahl, Diffusor aus gehärtetem Glas, mit 0,5m Gummikabel H07RN8-F, Silikon-dichtung, nicht befahrbar, inkl. Konverter, Einbaugehäuse muss separat bestellt werden.



LEISTUNG	LUMEN	CRI>	KELVIN	Ø x ET	FARBE	OPTIK	REFL.	ART.NR.
SYS 8W	131	80	3000	135 x 115	edelstahl	opal	114°	57-gh1244ahxw300en15
SYS 8W	131	80	3000	135 x 115	bronze	opal	114°	57-gh1244ahxw300en68
EINBAUGEHÄUSE INFO				ABBILDUNG	Ø x ET	FARBE	ART.NR.	
Einbaugehäuse, rund, für Spiacar, separat ordern					125 x 115	schwarz	57-ac014	
EINBAUGEHÄUSE INFO				ABBILDUNG	Ø x ET	FARBE	ART.NR.	
Einbaugehäuse, rund, für Spiacar, separat ordern					125 x 85	schwarz	57-ac273	



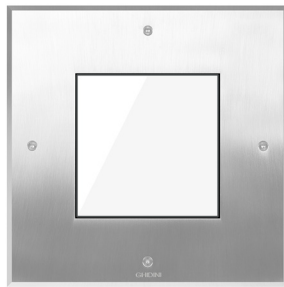

MAXISPIACAR

INFORMATION

Bodeneinbauleuchte, quadratisch, Aluminiumdruckguss, Abdeckring und Schrauben aus Edelstahl, Diffusor aus gehärtetem Glas, mit 0,5m Gummikabel H07RN8-F, Silikon-dichtung, Überfahrt mit max. 15km/h, Statische Belastung 2500 kg, inkl. Konverter, Einbaugehäuse muss separat bestellt werden.



LEISTUNG	LUMEN	CRI>	KELVIN	L x B x ET	FARBE	OPTIK	REFL.	ART.NR.
SYS 15W	870	80	3000	245 x 245 x 145	edelstahl	opal	82°	57-gh5323brxa300en15
SYS 15W	1533	90	3000	245 x 245 x 145	edelstahl	klar	58°	57-gh5323brft300en15
EINBAUGEHÄUSE INFO				ABBILDUNG	Ø x ET	FARBE	ART.NR.	
Einbaugehäuse, rund, für MAXI SPIACAR, separat ordern					225 x 140	schwarz	57-ac017	

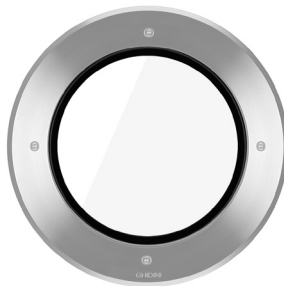

MAXISPIACAR

INFORMATION

Bodeneinbauleuchte, rund, Aluminiumdruckguss, Abdeckring und Schrauben aus Edelstahl, Diffusor aus gehärtetem Glas, mit 0,5m Gummikabel H07RN8-F, Silikon-dichtung, nicht befahrbar, inkl. Konverter, Einbaugehäuse muss separat bestellt werden.



LEISTUNG	LUMEN	CRI>	KELVIN	Ø x ET	FARBE	OPTIK	REFL.	ART.NR.
SYS 14W	1533	90	3000	245 x 145	edelstahl	klar	58°	57-gh5329brft300en15
SYS 14W	1533	90	3000	245 x 145	bronze	klar	58°	57-gh5329brft300en68
SYS 15W	870	80	3000	245 x 145	edelstahl	opal	82°	57-gh5329brxa300en15
SYS 15W	870	80	3000	245 x 145	bronze	opal	82°	57-gh5329brxa300en68
EINBAUGEHÄUSE INFO				ABBILDUNG	Ø x ET	FARBE	ART.NR.	
Einbaugehäuse, rund, für MAXI SPIACAR, separat ordern					225 x 140	schwarz	57-ac017	
DIFFUSOR INFO				ABBILDUNG	ART.NR.			
rutschfester Diffusor, rund, nach R12 DIN51130, für MAXI SPIACAR, separat ordern					57-ac105			





NEO

INFORMATION

Bodeneinbauleuchte, quadratisch, Aluminiumdruckguss, Abdeckring und Schrauben aus Edelstahl, Diffusor aus gehärtetem Glas, mit 0,5m Gummikabel H07RN8-F, Silikon-dichtung, Überfahrt mit max. 15km/h, Statische Belastung 2500 kg, inkl. Konverter, Einbaugehäuse muss separat bestellt werden.



LEISTUNG	LUMEN	CRI>	KELVIN	L x B x ET	FARBE	OPTIK	REFL.	ART.NR.
SYS 8W	914	90	3000	135 x 135 x 155	edelstahl	klar	58°	57-gh6616ahft300en15
EINBAUGEHÄUSE INFO				ABBILDUNG	Ø x ET	FARBE	ART.NR.	
Einbaugehäuse, rund, für NEO, separat ordern					125 x 155	schwarz	57-ac015	



NEO

INFORMATION

Bodeneinbauleuchte, rund, Aluminiumdruckguss, Abdeckring und Schrauben aus Edelstahl, Diffusor aus gehärtetem Glas, mit 0,5m Gummikabel H07RN8-F, Silikon-dichtung, Überfahrt mit max. 15km/h, Statische Belastung 2500 kg, inkl. Konverter, Einbautopf muss separat bestellt werden.



LEISTUNG	LUMEN	CRI>	KELVIN	Ø x ET	FARBE	OPTIK	REFL.	ART.NR.
SYS 8W	914	90	3000	135 x 155	edelstahl	klar	58°	57-gh6615ahft300en15
SYS 8W	914	90	3000	135 x 155	bronze	klar	58°	57-gh6615ahft300en88
EINBAUGEHÄUSE INFO				ABBILDUNG	Ø x ET	FARBE	ART.NR.	
Einbaugehäuse, rund, für NEO, separat ordern					125 x 155	schwarz	57-ac015	



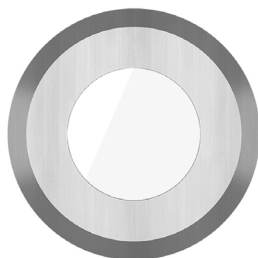

MAXISEGNO FLAT

INFORMATION	LEISTUNG	LUMEN	V DC	CRI>	KELVIN	Ø x ET	FARBE	OPTIK	REFL.	ART.NR.
Boden- / Wandeinbauleuchte, rund, Aluminiumdruckguss, Abdeckring aus Edelstahl, Diffusor aus gehärtetem Glas, mit 0,5m Gummikabel FR5FO-EM7-AD8, nicht befahrbar, exkl. Konverter, Einbaugehäuse muss separat bestellt werden.	LED 1W	27	24	80	3000	55 x 75-100	edelstahl	opal	115°	57-gh1119baxw300el15
	LED 1W	27	24	80	3000	55 x 75-100	bronze	opal	115°	57-gh1119baxw300el68
EINBAUGEHÄUSE INFO						ABBILDUNG	Ø x ET	FARBE	ART.NR.	
Einbaugehäuse, rund, für MAXISEGNO FLAT, separat ordern							50 x 75-100	schwarz	57-ac612	
WANDEINBAUGEHÄUSE INFO						ABBILDUNG	L x B x ET	FARBE	ART.NR.	
Wandeinbaugehäuse, quadratisch, für MAXISEGNO, separat ordern							105 x 72 x 54	gelb	57-ac297	

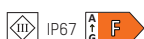

LED KONVERTER	INFORMATION	WATT	V DC	V AC	L x B x H	FARBE	ART.NR.
 IP67 Symbolbild	nicht dimmbar	14W	24	230	85 x 39 x 19	schwarz	57-ac1460024014fn67
	DALI dimmbar	24W	24	230	185 x 35 x 33	schwarz	57-ac1140024024fd67

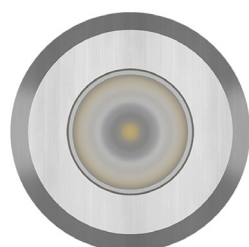

MAXISEGNO

INFORMATION	LEISTUNG	LUMEN	V DC	CRI>	KELVIN	Ø x ET	FARBE	OPTIK	REFL.	ART.NR.
Bodeneinbauleuchte, rund, Aluminiumdruckguss, Abdeckring aus Edelstahl, Diffusor aus gehärtetem Glas, mit 0,5m Gummikabel FR5FO-EM7-AD8, Silikondichtung, begehbar, Statische Belastung 500 kg, exkl. Konverter, Einbaugehäuse muss separat bestellt werden.	LED 4W	125	24	90	3000	55 x 100	edelstahl	klar	36°	57-gh1009bgmt300el15
	LED 4W	125	24	90	3000	55 x 100	bronze	klar	36°	57-gh1009bgmt300el68
EINBAUGEHÄUSE INFO						ABBILDUNG	Ø x ET	FARBE	ART.NR.	
Einbaugehäuse, rund, für MAXISEGNO, separat ordern							50 x 75-100	schwarz	57-ac612	

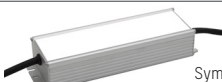

LED KONVERTER	INFORMATION	WATT	V DC	V AC	L x B x H	FARBE	ART.NR.
 IP67 Symbolbild	nicht dimmbar	14W	24	230	85 x 39 x 19	schwarz	57-ac1460024014fn67
	DALI dimmbar	24W	24	230	185 x 35 x 33	schwarz	57-ac1140024024fd67





MARGIN WALL GRID

INFORMATION

Wandeinbauleuchte, quadratisch, Aluminiumdruckguss, Abdeckung und Schrauben aus Edelstahl, Diffusor aus gehärtetem Glas, Silikon-dichtung, Vandalismus-sicher, inkl. Konverter, Einbaugehäuse muss separat bestellt werden.

LEISTUNG	LUMEN	CRI>	KELVIN	L x B x ET	FARBE	OPTIK	REFL.	ART.NR.
SYS 7W	7	90	3000	243 x 67 x 140	anthrazit	opal	asymetrisch	57-gh6507ahxa300en05
SYS 7W	7	90	3000	243 x 67 x 140	hellgrau	opal	asymetrisch	57-gh6507ahxa300en19

EINBAUGEHÄUSE INFO

Einbaugehäuse, quadratisch, für MARGIN WALL GRID, separat ordern

ABBILDUNG



L x B x ET
242 x 67 x 140

FARBE
schwarz

ART.NR.
57-ac022





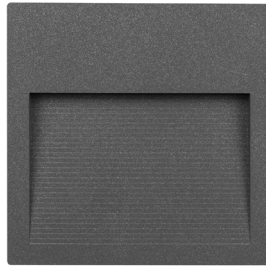

VERSO FLAT

INFORMATION

Wandeinbauleuchte, quadratisch, Aluminiumdruckguss, Abdeckung aus beschichtetem Aluminium, Schrauben aus Edelstahl, Diffusor aus gehärtetem Glas, Silikon-dichtung, inkl. Konverter, Einbaugehäuse muss separat bestellt werden.



LEISTUNG	LUMEN	CRI>	KELVIN	L x B x ET	FARBE	OPTIK	REFL.	ART.NR.
SYS 4W	86	90	3000	120 x 120 x 57	anthrazit	mikroprismatik	asymetrisch	57-gh1165bgxp300en05
SYS 4W	86	90	3000	120 x 120 x 57	hellgrau	mikroprismatik	asymetrisch	57-gh1165bgxp300en19

EINBAUGEHÄUSE INFO	ABBILDUNG	L x B x ET	FARBE	ART.NR.
Einbaugehäuse, quadratisch, für VERSO FLAT R, separat ordern		124 x 124 x 57	edelstahl	57-ac263

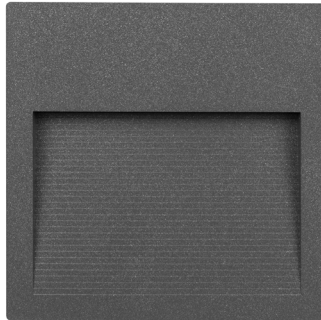

MAXIVERSO FLAT

INFORMATION

Wandeinbauleuchte, quadratisch, Aluminiumdruckguss, Abdeckung aus beschichtetem Aluminium, Schrauben aus Edelstahl, Diffusor aus gehärtetem Glas, Silikon-dichtung, inkl. Konverter, Einbaugehäuse muss separat bestellt werden.



LEISTUNG	LUMEN	CRI>	KELVIN	L x B x ET	FARBE	OPTIK	REFL.	ART.NR.
SYS 10W	98	90	3000	200 x 200 x 57	anthrazit	mikroprismatik	asymetrisch	57-gh1166caxp300en05
SYS 10W	98	90	3000	200 x 200 x 57	hellgrau	mikroprismatik	asymetrisch	57-gh1166caxp300en19

EINBAUGEHÄUSE INFO	ABBILDUNG	L x B x ET	FARBE	ART.NR.
Einbaugehäuse, quadratisch, für MAXIVERSO FLAT R, separat ordern		203 x 203 x 57	edelstahl	57-ac262



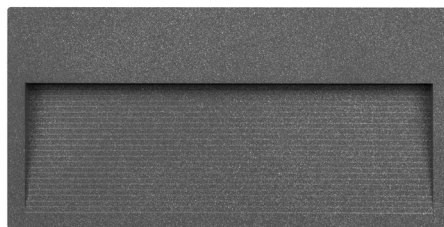

LONGVERSO FLAT

INFORMATION

Wandeinbauleuchte, rechteckig, Aluminiumdruckguss, Abdeckung aus beschichtetem Aluminium, Schrauben aus Edelstahl, Diffusor aus gehärtetem Glas, Silikon-dichtung, inkl. Konverter, Einbaugehäuse muss separat bestellt werden.

LEISTUNG	LUMEN	CRI>	KELVIN	L x B x ET	FARBE	OPTIK	REFL.	ART.NR.
SYS 10W	96	90	3000	240 x 120 x 57	anthrazit	mikroprismatik	asymetrisch	57-gh1164caxp300en05
SYS 10W	96	90	3000	240 x 120 x 57	hellgrau	mikroprismatik	asymetrisch	57-gh1164caxp300en19

EINBAUGEHÄUSE INFO

Einbaugehäuse, rechteckig, für LONGVERSO FLAT R, separat ordern

ABBILDUNG



L x B x ET	FARBE	ART.NR.
243 x 123 x 50	edelstahl	57-ac258





PASSO

INFORMATION

Wandeinbauleuchte, rechteckig, Aluminiumdruckguss, Abdeckung aus beschichtetem Aluminium, Schrauben aus Edelstahl, Diffusor aus gehärtetem Glas, mit 0,2m Gummikabel H05RN-F, Silikon-dichtung, inkl. Konverter, Einbaugehäuse muss separat bestellt werden.

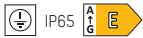

LEISTUNG	LUMEN	CRI>	KELVIN	L x B x ET	FARBE	OPTIK	REFL.	ART.NR.
SYS 3W	197	90	3000	115 x 80 x 50	weiß	klar	asymetrisch	57-gh1604baat300env1
SYS 3W	197	90	3000	115 x 80 x 50	schwarz	klar	asymetrisch	57-gh1604baat300env2

EINBAUGEHÄUSE INFO

Einbaugehäuse, rechteckig, für PASSO, separat ordern



ABBILDUNG

L x B x ET

FARBE

gelb

ART.NR.

57-ac503

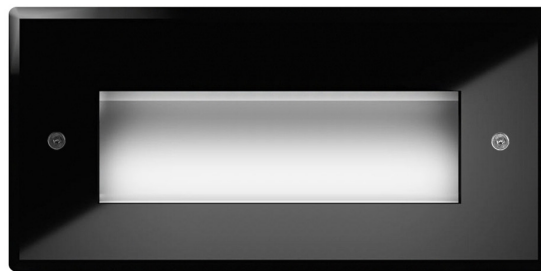

LONGPASSO

INFORMATION

Wandeinbauleuchte, rechteckig, Aluminiumdruckguss, Abdeckung aus beschichtetem Aluminium, Schrauben aus Edelstahl, Diffusor aus gehärtetem Glas, mit 0,2m Gummikabel H05RN-F, Silikon-dichtung, inkl. Konverter, Einbaugehäuse muss separat bestellt werden.



LEISTUNG	LUMEN	CRI>	KELVIN	L x B x ET	FARBE	OPTIK	REFL.	ART.NR.
SYS 7W	728	90	3000	165 x 80 x 55	weiß	klar	asymetrisch	57-gh1602etat300env1
SYS 7W	728	90	3000	165 x 80 x 55	schwarz	klar	asymetrisch	57-gh1602etat300env2

EINBAUGEHÄUSE INFO

Einbaugehäuse, rechteckig, für LONGPASSO, separat ordern



ABBILDUNG

L x B x ET

FARBE

gelb

ART.NR.

57-ac004



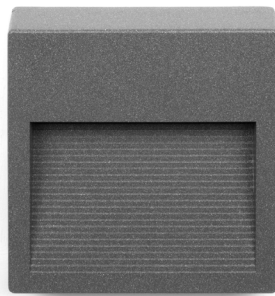

VERSO FLAT

INFORMATION	LEISTUNG	LUMEN	CRI>	KELVIN	B x H x T	FARBE	OPTIK	REFL.	ART.NR.
Wandaufbauleuchte, quadratisch, Aluminiumdruckguss, Abdeckung aus beschichtetem Aluminium, Schrauben aus Edelstahl, Diffusor aus gehärtetem Glas, Silikondichtung, inkl. Konverter.	SYS 4W	86	90	3000	120 x 120 x 25	anthrazit	mikroprismatik	asymetrisch	57-gh1136bgxp300en05
	SYS 4W	86	90	3000	120 x 120 x 25	hellgrau	mikroprismatik	asymetrisch	57-gh1136bgxp300en19

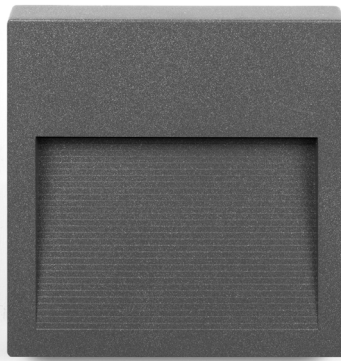

MAXIVERSO FLAT

INFORMATION	LEISTUNG	LUMEN	CRI>	KELVIN	B x H x T	FARBE	OPTIK	REFL.	ART.NR.
Wandaufbauleuchte, quadratisch, Aluminiumdruckguss, Abdeckung aus beschichtetem Aluminium, Schrauben aus Edelstahl, Diffusor aus gehärtetem Glas, Silikondichtung, inkl. Konverter.	SYS 10W	98	90	3000	200 x 200 x 25	anthrazit	mikroprismatik	asymetrisch	57-gh1137caxp300en05
	SYS 10W	98	90	3000	200 x 200 x 25	hellgrau	mikroprismatik	asymetrisch	57-gh1137caxp300en19

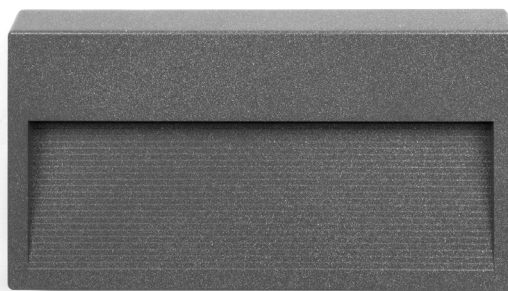

LONGVERSO FLAT

INFORMATION	LEISTUNG	LUMEN	CRI>	KELVIN	B x H x T	FARBE	OPTIK	REFL.	ART.NR.
Wandaufbauleuchte, rechteckig, Aluminiumdruckguss, Abdeckung aus beschichtetem Aluminium, Schrauben aus Edelstahl, Diffusor aus gehärtetem Glas, Silikondichtung, inkl. Konverter.	SYS 10W	96	90	3000	240 x 120 x 25	anthrazit	mikroprismatik	asymetrisch	57-gh1138caxp300en05
	SYS 10W	96	90	3000	240 x 120 x 25	hellgrau	mikroprismatik	asymetrisch	57-gh1138caxp300en19







VERSO FLAT

INFORMATION	LEISTUNG	LUMEN	CRI>	KELVIN	Ø x T	FARBE	OPTIK	REFL.	ART.NR.
Wandaufbauleuchte, rund, Aluminiumdruckguss, Abdeckung aus beschichtetem Aluminium, Schrauben aus Edelstahl, Diffusor aus gehärtetem Glas, Silikondichtung, inkl. Konverter.	SYS 5W	64	90	3000	140 x 25	anthrazit	mikroprismatik	asymetrisch	57-gh1392bgxp300en05
	SYS 5W	64	90	3000	140 x 25	hellgrau	mikroprismatik	asymetrisch	57-gh1392bgxp300en19



MAXIVERSO FLAT

INFORMATION	LEISTUNG	LUMEN	CRI>	KELVIN	Ø x T	FARBE	OPTIK	REFL.	ART.NR.
Wandaufbauleuchte, rund, Aluminiumdruckguss, Abdeckung aus beschichtetem Aluminium, Schrauben aus Edelstahl, Diffusor aus gehärtetem Glas, Silikondichtung, inkl. Konverter.	SYS 10W	98	90	3000	220 x 26	anthrazit	mikroprismatik	asymetrisch	57-gh1393caxp300en05
	SYS 10W	98	90	3000	220 x 26	hellgrau	mikroprismatik	asymetrisch	57-gh1393caxp300en19







MICROBIVIO

INFORMATION

Wandaufbauleuchte, quadratisch, Aluminiumdruckguss, Abdeckung aus beschichtetem Aluminium, Schrauben aus Edelstahl, Diffusor aus gehärtetem Glas, Silikondichtung, inkl. Konverter.

LEISTUNG	LUMEN	CRI>	KELVIN	B x H x T	FARBE	LICHTAUSTRITT	OPTIK	REFL.	ART.NR.
SYS 8W	728	90	3000	92 x 90 x 92	anthrazit	direkt	klar	wallwasher	57-gh1152ahat300en05
SYS 8W	728	90	3000	92 x 90 x 92	hellgrau	direkt	klar	wallwasher	57-gh1152ahat300en19
SYS 8W	371	90	3000	92 x 90 x 92	anthrazit	direkt / indirekt	klar	wallwasher	57-gh1153ahat300en05
SYS 8W	371	90	3000	92 x 90 x 92	hellgrau	direkt / indirekt	klar	wallwasher	57-gh1153ahat300en19



MINIMODO

INFORMATION

Wandaufbauleuchte, rechteckig, Aluminiumdruckguss, Abdeckung aus beschichtetem Aluminium, Schrauben aus Edelstahl, Diffusor aus gehärtetem Glas, Silikondichtung, inkl. Konverter.

LEISTUNG	LUMEN	CRI>	KELVIN	B x H x T	FARBE	LICHTAUSTRITT	OPTIK	REFL.	ART.NR.
SYS 8W	630	90	3000	180 x 111 x 90	anthrazit	direkt	klar	43°	57-gh1332camt300en05
SYS 8W	630	90	3000	180 x 111 x 90	hellgrau	direkt	klar	43°	57-gh1332camt300en19
SYS 16W	2x 628	90	3000	180 x 111 x 90	anthrazit	direkt / indirekt	klar	43°	57-gh1333famt300en05
SYS 16W	2x 628	90	3000	180 x 111 x 90	hellgrau	direkt / indirekt	klar	43°	57-gh1333famt300en19





MEGAPUNTO

INFORMATION

Deckenaufbauleuchte, rund, Aluminiumdruckguss, Abdeckung aus beschichtetem Aluminium, Schrauben aus Edelstahl, Diffusor aus gehärtetem Glas, mit Gummikabel H05RN-F, Silikondichtung, inkl. Konverter.



LEISTUNG	LUMEN	CRI>	KELVIN	Ø x H	FARBE	OPTIK	REFL.	ART.NR.
SYS 9W	525	80	3000	75 x 80	anthrazit	klar	65°	57-gh1220lvft300en05
SYS 9W	525	80	3000	75 x 80	hellgrau	klar	65°	57-gh1220lvft300en19



MEGAPUNTO

INFORMATION

Deckenaufbauleuchte, quadratisch, Aluminiumdruckguss, Abdeckung aus beschichtetem Aluminium, Schrauben aus Edelstahl, Diffusor aus gehärtetem Glas, mit Gummikabel H05RN-F, Silikondichtung, inkl. Konverter.

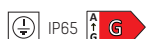

LEISTUNG	LUMEN	CRI>	KELVIN	L x B x H	FARBE	OPTIK	REFL.	ART.NR.
SYS 9W	525	80	3000	75 x 75 x 80	anthrazit	klar	65°	57-gh1221lvft300en05
SYS 9W	525	80	3000	75 x 75 x 80	hellgrau	klar	65°	57-gh1221lvft300en19



TONDO

INFORMATION

Pollerleuchte, rund, beschichteter Aluminiumdruckguss, Schrauben aus Edelstahl, Diffusor aus Polycarbonat, mit 0,5m Gummikabel H05RN-F, Silikondichtung, inkl. Konverter, Bodenanker muss separat bestellt werden.

LEISTUNG	LUMEN	CRI>	KELVIN	Ø x H	FARBE	OPTIK	REFL.	ART.NR.
SYS 9W	166	80	3000	100 x 175	anthrazit	klar	360°	57-gh1457lvxt300en05
SYS 9W	166	80	3000	100 x 175	hellgrau	klar	360°	57-gh1457lvxt300en19
SYS 9W	75	80	3000	100 x 175	anthrazit	klar	180°	57-gh1456lvxt300en05
SYS 9W	75	80	3000	100 x 175	hellgrau	klar	180°	57-gh1456lvxt300en19



TONDO

INFORMATION

Pollerleuchte, rund, beschichteter Aluminiumdruckguss, Schrauben aus Edelstahl, Diffusor aus Polycarbonat, mit 0,5m Gummikabel H05RN-F, Silikondichtung, inkl. Konverter, Bodenanker muss separat bestellt werden.

LEISTUNG	LUMEN	CRI>	KELVIN	Ø x H	FARBE	OPTIK	REFL.	ART.NR.
SYS 14W	414	90	3000	100 x 600	anthrazit	klar	360°	57-gh1372brxt300en05
SYS 14W	414	90	3000	100 x 600	hellgrau	klar	360°	57-gh1372brxt300en19
SYS 14W	187	90	3000	100 x 600	anthrazit	klar	180°	57-gh1445brxt300en05
SYS 14W	187	90	3000	100 x 600	hellgrau	klar	180°	57-gh1445brxt300en19
SYS 14W	414	90	3000	100 x 900	anthrazit	klar	360°	57-gh1375brxt300en05
SYS 14W	414	90	3000	100 x 900	hellgrau	klar	360°	57-gh1375brxt300en19
SYS 14W	187	90	3000	100 x 900	anthrazit	klar	180°	57-gh1446brxt300en05
SYS 14W	187	90	3000	100 x 900	hellgrau	klar	180°	57-gh1446brxt300en19

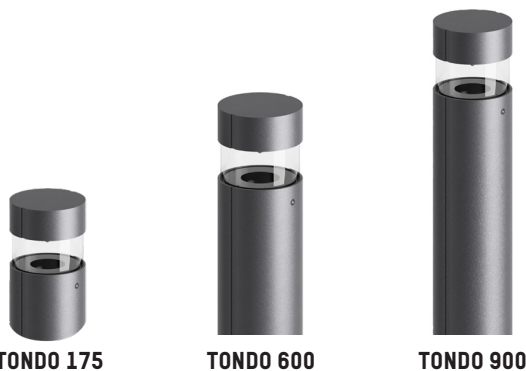
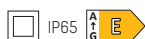

TONDO 175

TONDO 600

TONDO 900

BODENANKER



INFORMATION

Bodenanker, für TONDO, edelstahl, separat ordern

ART.NR.

57-ac274



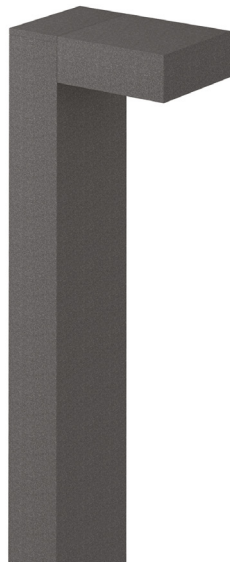

COMPATTO P

INFORMATION

Pollerleuchte, rechteckig, beschichteter Aluminiumdruckguss, Schrauben aus Edelstahl, Diffusor aus Polycarbonat, mit 0,5m Gummikabel H05RN-F, Silikondichtung, inkl. Konverter, Bodenanker muss separat bestellt werden.

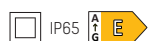

LEISTUNG	LUMEN	CRI>	KELVIN	L x B x H	FARBE	OPTIK	REFL.	ART.NR.
SYS 14W	995	90	3000	80 x 125 x 500	anthrazit	klar	91°	57-gh1427caft300en05
SYS 14W	995	90	3000	80 x 125 x 500	hellgrau	klar	91°	57-gh1427caft300en19

BODENANKER



INFORMATION

Bodenanker, für COMPATTO P, edelstahl, separat ordern

ART.NR.

57-ac274







MEGASEGNO SPOT

INFORMATION

Aufbaustrahler, rund, beschichteter Aluminiumdruckguss, Schrauben aus Edelstahl, Diffusor aus gehärtetem Glas, Silikondichtung, inkl. Konverter, Zubehör muss separat bestellt werden.

LEISTUNG	LUMEN	CRI>	KELVIN	Ø x L x H	FARBE	OPTIK	REFL.	ART.NR.
SYS 9W	525	80	3000	70 x 90 x 106	anthrazit	klar	65°	57-gh1110lvft300en05
SYS 9W	525	80	3000	70 x 90 x 106	hellgrau	klar	65°	57-gh1110lvft300en19
ZUBEHÖR INFO				ABBILDUNG	Ø x H	FARBE	ART.NR.	
Erdspieß, für MEGASEGNO SPOT, separat ordern					35 x 170	schwarz	57-ac203	
ZUBEHÖR INFO				ABBILDUNG	FARBE	ART.NR.		
Visier, für MEGASEGNO SPOT, separat ordern					schwarz	57-ac660		





MINIPARIO

INFORMATION

Aufbaustrahler, rund, beschichteter Aluminiumdruckguss, Schrauben aus Edelstahl, Diffusor aus gehärtetem Glas, mit 0,5m Gummikabel H07RN8-F, Silikon-dichtung, inkl. Konverter, Zubehör muss separat bestellt werden.

LEISTUNG	LUMEN	CRI>	KELVIN	Ø x L x H	FARBE	OPTIK	REFL.	ART.NR.
SYS 8W	983	90	4000	102 x 129 x 216	anthrazit	klar	58°	57-gh1129lvft400en05
SYS 8W	983	90	4000	102 x 129 x 216	hellgrau	klar	58°	57-gh1129lvft400en19

ZUBEHÖR INFO

Blendschutzgitter, für MINIPARIO, separat ordern



ABBILDUNG

ART.NR.
57-ac231

ZUBEHÖR INFO

Erdspieß, für MINIPARIO, separat ordern

ABBILDUNG



Ø x H
35 x 170

FARBE
schwarz

ART.NR.
57-ac257

ZUBEHÖR INFO

Visier, für MINIPARIO, separat ordern



FARBE
schwarz

ART.NR.
57-ac224





MICROFARO FLAT

INFORMATION

Aufbaustrahler, quadratisch, beschichteter Aluminiumdruckguss, Schrauben aus Edelstahl, Diffusor aus gehärtetem Glas, mit 0,5m Gummikabel H07RN8-F, Silikondichtung, inkl. Konverter, Zubehör muss separat bestellt werden.

LEISTUNG	LUMEN	CRI>	KELVIN	L x B x H	FARBE	OPTIK	REFL.	ART.NR.
SYS 9W	480	80	3000	90 x 90 x 191	anthrazit	klar	29°	57-gh1396lvmt300en05
SYS 9W	480	80	3000	90 x 90 x 191	hellgrau	klar	29°	57-gh1396lvmt300en19

ZUBEHÖR INFO	ABBILDUNG	Ø x H	FARBE	ART.NR.
Erdspieß, für MICROFARO FLAT, separat ordern		35 x 170	schwarz	57-ac203



FARO FLAT

INFORMATION

Aufbaustrahler, quadratisch, beschichteter Aluminiumdruckguss, Schrauben aus Edelstahl, Diffusor aus gehärtetem Glas, mit 0,5m Gummikabel H07RN8-F, Silikondichtung, inkl. Konverter.

LEISTUNG	LUMEN	CRI>	KELVIN	L x B x H	FARBE	OPTIK	REFL.	ART.NR.
SYS 18W	1001	80	3000	125 x 125 x 108	anthrazit	klar	42°	57-gh1397faft300en05
SYS 18W	1001	80	3000	125 x 125 x 108	hellgrau	klar	42°	57-gh1397faft300en19





MINIPARIO EXTENSION

INFORMATION

Auslegerleuchte, rund, beschichteter Aluminiumdruckguss, Schrauben aus Edelstahl, Diffusor aus gehärtetem Glas, mit 0,5m Gummikabel H07RN8-F, Silikondichtung, inkl. Konverter.

LEISTUNG	LUMEN	CRI>	KELVIN	L x B x H	FARBE	OPTIK	REFL.	ART.NR.
SYS 14W	1570	90	3000	500 x 102 x 98	anthrazit	klar	58°	57-gh1147brft300en05
SYS 14W	1570	90	3000	500 x 102 x 98	hellgrau	klar	58°	57-gh1147brft300en19

ZUBEHÖR INFO

Blendschutzgitter, für MINIPARIO EXTENSION, separat ordern

ABBILDUNG



ART.NR.

57-ac231

ZUBEHÖR INFO

Visier, für MINIPARIO EXTENSION, separat ordern

ABBILDUNG



FARBE

schwarz

ART.NR.

57-ac224











AUSTRIA | MOLTO LUCE GMBH

HEADQUARTERS WELS
Office & Showroom
Europastraße 45
4600 Wels
T: +43 7242 698-0
M: office@moltoluce.com

SWITZERLAND | MOLTO LUCE AG

LENZBURG
Office
Niederlenzerstraße 25
5600 Lenzburg
T: +41 62 885 70 30
M: office.lenzburg@moltoluce.com

www.moltoluce.com

MOLTO LUCE®

